

Donaldson®
Torit®

**TORIT® POWERCORE®
DUST COLLECTORS**

TG SERIES

 PowerCore®



SMARTER, SMALLER COLLECTORS

The Torit® PowerCore® TG Series designed for thermally generated dust is reshaping the future of dust and fume collection technology. Torit PowerCore TG is in a category by itself with a footprint up to 65% smaller than most cartridge collectors and smarter technology housed in the widest range of completely packaged and assembled units available up to 10,000 cfm. Torit PowerCore TG is the new way to get cleaner air in welding, laser cutting, plasma cutting, and thermal spray applications.

Torit PowerCore TG collectors' strong and sleek all-welded housing is the ideal fit as a stand-alone on the plant floor or integrated into an OEM design. Factor in the energy saver package, quiet motor and smart controls specifically designed for metalworking, and the choice is clear. Torit PowerCore TG is the best combination of footprint, appearance and performance.

TORIT POWERCORE TG

- **SMARTER**
- **SMALLER**
- **EFFICIENT**
- **COST EFFECTIVE**
- **COMPLETE**



UP TO **65%** SMALLER
FOOTPRINT THAN MOST
CARTRIDGE COLLECTORS

Torit PowerCore TG4
vs.
Traditional 8-Cartridge Filter Caghouse
5000 cfm (8493 m³/h) collectors

POWERCORE FILTER PACK – NOT A BAG, NOT A CARTRIDGE

What makes Torit PowerCore TG so smart? The difference is compact PowerCore filter packs with easy-grip handles that don't require tools. A complete departure from the traditional cartridge filter, offset-stack PowerCore filter packs with high performance flame-retardant Ultra-Web® filter media combine Donaldson Torit's proprietary technologies that are proven in the field for more than 10 years. Best of all, one PowerCore filter pack replaces up to three traditional cartridge filters, resulting in fewer, faster filter changes.

SMALLER FOOTPRINTS

Save valuable floor space

SMARTER FILTER PACKS

Reduce maintenance and don't require tools

EFFICIENT FILTER MEDIA

Rated MERV 13

COST EFFECTIVE

PowerCore filtration technology means reduced freight and installation costs

COMPLETELY PACKAGED

Completely assembled and pre-wired



1 POWERCORE FILTER PACK

replaces up to



3 CARTRIDGE FILTERS



THE NEW STANDARD IN DUST COLLECTION

ULTRA-WEB MEDIA

PowerCore filter packs employ Donaldson Torit's proprietary Ultra-Web fine fiber technology, and are backed by more than ten years of field tests.

Durable Ultra-Web fine fibers intercept even the smallest dust particles on the surface of the flutes. This surface-loading keeps the filter pack cleaner and improves the effectiveness of pulse cleaning, thus lowering both operational pressure drop and energy use.

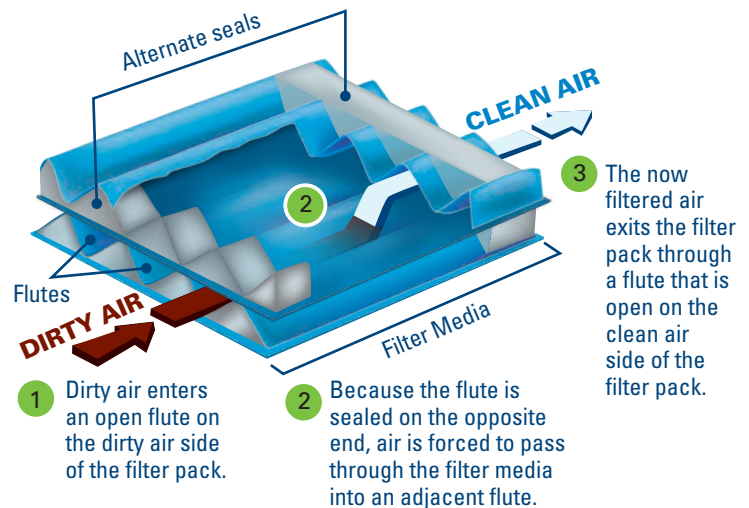
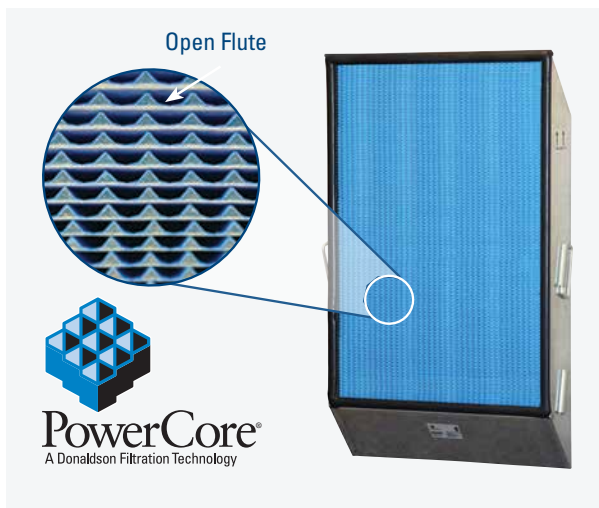

HIGH PERFORMANCE FILTER MEDIA

In a dramatic departure from conventional cartridge filters, Donaldson leverages over 100 years of air filtration experience in the development of Torit PowerCore TG filter packs with flame-retardant Ultra-Web media. Ultra-Web fine fiber media incorporates a durable layer of premium fine fiber which is designed to intercept even the smallest dust and fume particles at the surface of the media flutes.

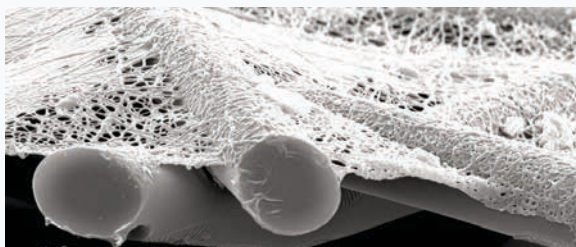

Clean Ultra-Web Media

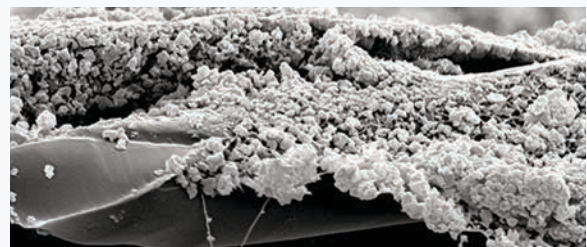

Surface-Loaded Ultra-Web Media
(substrate still clean)

Donaldson Torit Ultra-Web technology always delivers high efficiency filters that last. Independent laboratory testing conducted on PowerCore TG filter packs with Ultra-Web media have a Minimum Efficiency Reporting Value (MERV) up to 15 based on ASHRAE 52.2 test standard.

OPTIMIZED AS A SYSTEM

SMARTER FILTER CLEANING

Torit PowerCore TG collectors include a new state-of-the-art ZERO-Turn Power Pulse Cleaning System which is specifically designed to work in tandem with PowerCore TG filter packs and surface-loading Ultra-Web media. It delivers maximum cleaning energy in straight-line paths through the media and easily pulses the dust out of the fluted channels.

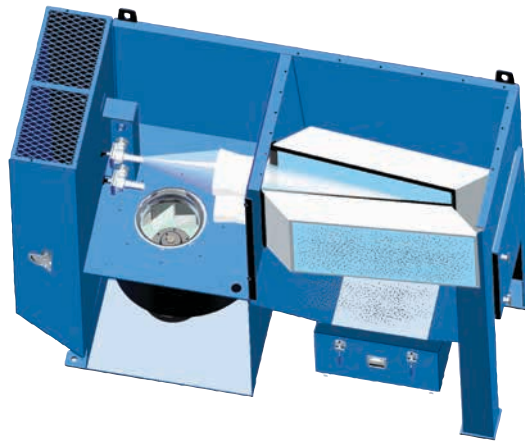

**ZERO-Turn Power Pulse Cleaning System
TG Series**

BETTER RECOVERY

What about those job shifts of cutting typical 10 gauge sheet metal today and 1/4" plate tomorrow? No problem for versatile and flexible PowerCore filter packs cleaned by the channeled pulse energy of the ZERO-Turn Power Pulse Cleaning System. PowerCore filter packs recover more easily than traditional cartridge filters from dramatic spikes in pressure drop during pulse cleaning. The result is longer filter life.

Better Cleaning Prolongs Filter Life

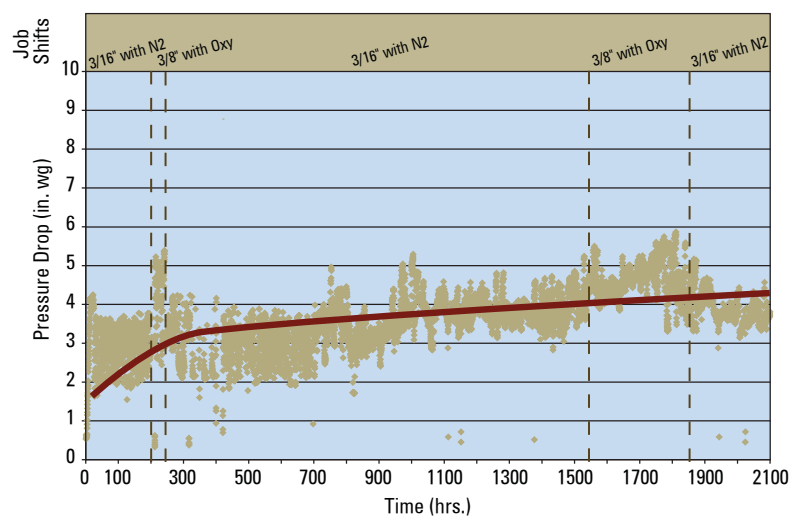

PACKED WITH POWER

COMPLETELY PACKAGED

With a footprint up to 65% smaller, Torit PowerCore TG collectors provide the widest range of completely packaged units available up to 10,000 cfm.

COMPLETELY ASSEMBLED

Custom engineered components and integrated electrical controls in combination with Torit PowerCore filtration technology provide a finished product of superior quality.

ALL WELDED

Strong and durable, all-welded TG dust collectors are the ideal fit as a stand alone on the plant floor or integrated into OEM designs.

DOWNWARD AIRFLOW ADVANTAGE

EPA-sponsored research has shown that “superior performance results from downward flow of the dirty airstream, reducing re-deposition of dust onto filter packs.”

EASY FILTER ACCESS

One large access door and quick-release T-Handles provide immediate access to the easy-grip PowerCore filter packs. No tools required. Lock-out capability available.

ZERO-TURN POWER PULSE CLEANING SYSTEM

Superior cleaning effectiveness is fully enclosed for quiet operation.

QUIET INTEGRATED FAN PACKS

High-performance fans are mounted at the base of the unit for maximum noise control.



INTEGRATED ELECTRICAL CONTROLS

Torit Delta P and Delta P Plus Control Boards manage all of the collector functions, including the fan, the filter differential, and the pulse cleaning system.

24VDC MOTOR START/STOP FEEDBACK RELAY

Allows an external signal to automate the remote start of the collector fan from other equipment such as a laser table.

TORIT AIRFLOW CONTROLLER WITH VFD

Allows the blower to automatically maintain the prescribed airflow and harness energy savings.

PARTICULATE SENSOR

Detects dust leaks past the filters; shuts off the dust collector and turns on a visual alarm.

BUILT-IN SPARK ABATEMENT

The Inline Spark Cooler by Blender Products, Inc. arrests sparks with air, reducing the frequency of sparks reaching any combustible dust collected on the surface of the filter media. The Torit TG Series Low-Inlet Box is a settling chamber which allows particulate to drop out.

BUILT-IN SAFETY FEATURES

The reinforced TG housing supports top-mount explosion vents, side-mount explosion vents, explosion suppression systems, fire suppression systems, heat sensors, alarm strobes, and more.

ENERGY SAVER PACKAGE

The combination of Torit PowerCore filter packs with Ultra-Web media, the Torit Airflow Controller with VFD, and Premium Efficiency motors make up one powerful Energy Saver Package.



SMARTER RESULTS IN MANY WAYS

HOW SMALLER MEANS SMARTER OPERATION

Torit PowerCore TG collectors are custom engineered for thermally generated dust and fume. TG collectors are completely packaged. They arrive completely assembled. They are pre-wired. TG collectors are purposely designed to take the complexity out of installation efforts and provide a finished product of superior quality.



7 Smart Ways to Save Big

1. PowerCore TG collectors are smaller and weigh less
2. Smaller collectors use less floor space
3. Smaller collectors fit into tight spaces
4. Smaller collectors are easily transported or moved
5. Smaller collectors have fewer filters
6. Fewer filters mean less downtime and less maintenance
7. Completely packaged, assembled, and pre-wired TG collectors simplify the buying experience

REAL COST CONTROL

The results are clear. Significant savings can be realized by purchasing smaller, smarter, completely packaged, fully assembled and pre-wired TG Series dust and fume collectors. TG Series collectors with innovative PowerCore filtration technology stand for:

- Reduced freight costs
- Reduced installation costs
- Reduced on-site electrical wiring costs
- Space savings
- Fewer filter changes
- Lower maintenance costs
- Energy savings



ENVIRONMENTALLY FRIENDLY

ENERGY SAVER PACKAGE

All good things come in threes. Torit PowerCore TG collectors offer three powerful components that allow significant energy savings. The combination can't be beat. The energy savings from using the TG Energy Saver Package can generally offset higher component costs within approximately 5,000 hours based on current average utility rates. Industry rebates from local utility may apply for use of the Torit Airflow Controller with VFD and Premium Efficiency motors, which helps to offset initial project costs.

The first building block for energy savings is comprised of TG filter packs with Ultra-Web media. Donaldson's Ultra-Web media technology provides lower pressure drop due to superior surface-loading and better dust-shedding capabilities throughout the entire filter life. Lower pressure drop during the life of a filter eases the work load on the fan. As a result, energy consumption is lowered and energy savings increase.



The second building block for energy savings is made up by the Torit Airflow Controller with VFD (Variable Frequency Drive). This control panel is set-up only once during the collector start-up. It maintains the required minimum transport velocity through the collector without any manual adjustments. Therefore, the fan motor spins only as fast as it has to and generally spins at a lower RPM. Spinning at a lower RPM reduces the fan motor's energy consumption, and energy savings can be harnessed. Also, since the fan is spinning at less than full speed, the noise radiating from the fan housing and from the fan motors is also reduced significantly.



The third building block for energy savings is a Premium Efficiency Motor, which is designed to boost efficiency with less heat. Since less heat is generated, less energy is needed to cool the motor with a fan – further improving energy savings.



Shown above is a Baldor Premium Efficiency Motor.

MAKING MAINTENANCE EASIER

EASY FILTER MAINTENANCE

Torit PowerCore TG filter packs are easy to remove and install. No tools required. Better yet, it takes only one person to do the job. Just open the T-Handles on the front access door and open the proprietary rotary filter locks to get instant access to the filter packs. PowerCore filter packs are lightweight and remain below the 50-pound OSHA Lift Limit even at the end of their life cycle.



EASY CLEANING

The Low-Inlet Box employs a dust removal concept that utilizes the velocity and physical properties inherent in the dust to effectively remove particulate from the system flow at a negligible pressure loss to the system. The dust drops out and collects into a dust drawer located at the bottom of the chamber. Quick-release latches allow fast removal of the dust drawer for clean up.



INSIDE THE POWERCORE TG

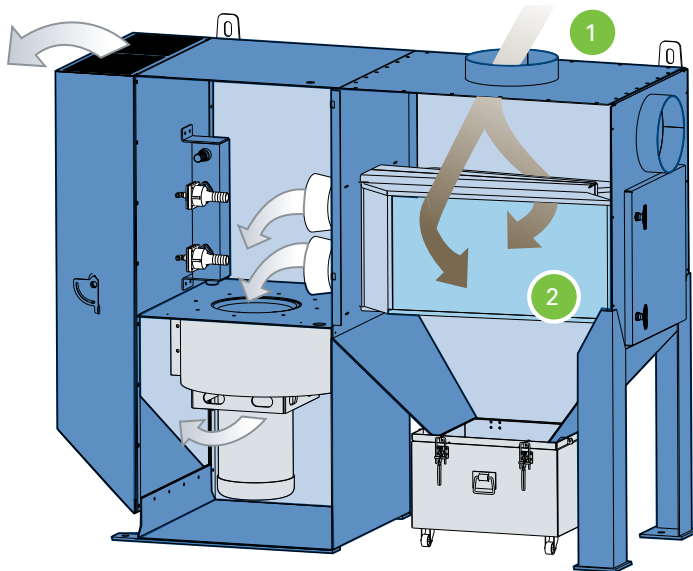

STANDARD OPERATION

- 1 Dirty airflow from manufacturing process.
- 2 Dirty air is forced downward and through the filter packs, which collect dust and fume particles on the surface of the media flutes.

FILTER CLEANING OPERATION

- 3 The ZERO-Turn Power Pulse Cleaning System discharges sharp pulses of compressed air in succession on valve at a time.
- 4 Dust and fume particles dislodge easily with Torit PowerCore filter packs, and filter life is prolonged.
- 5 Clean air returns to plant.

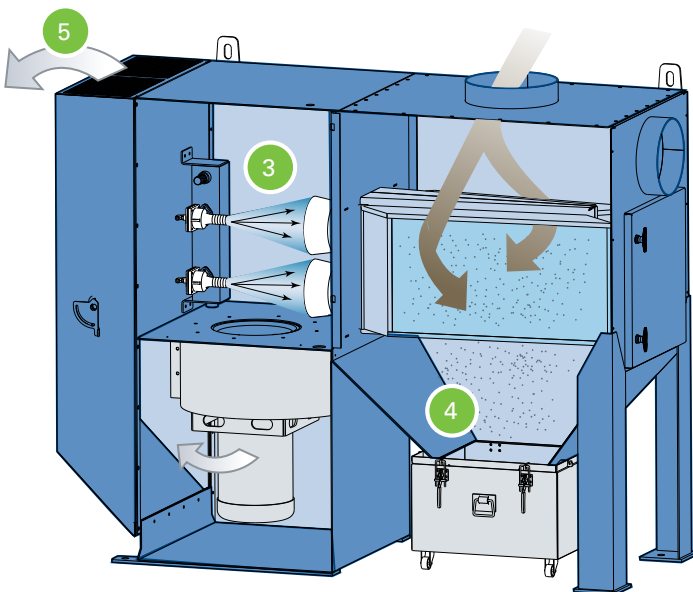

ADDRESSING SAFETY CONCEPTS

Donaldson® Torit® manufactures and partners with recognized experts to provide solutions for critical processes where harmful particulate must be controlled.

Torit PowerCore TG Collectors Offer:

- Reinforced Housing Construction
- Low-Inlet Drop-Out Box
- Inline Spark Cooler
- Composite-Style Explosion Relief Panels
- Fire Suppression
- Explosion Suppression
- Heat Sensors
- Alarm Strobes

OPERATING ADVANTAGES & CONDITIONS

OPERATING CONDITIONS FOR TG COLLECTORS

TG MODELS	TG2	TG4	TG6	TG8	TG12
Horsepower	5 (3)	7.5 (5,10)	10 (15)	15 (20)	20 (30)
Sound Level db(A)	71-74 dB(A) depending on HP. Peak pulse noise is 92.7 dB(A)				
External Static Pressure	See system performance curves				
Housing Construction	3/16 - 12 gauge steel compliant with IBC2006				
STD Housing Rating	-12" (304.8 mm)	-12" (304.8 mm)	-15" (381.0 mm)	-15" (381.0 mm)	-15" (381.0 mm)
Reinforced Housing Rating	.15 bar	.15 bar	.2 bar	.32 bar	.16 bar
Seismic Spectral Acceleration	$S_s = 1.5$ $S_1 = 0.6$				
Wind Load Rating (mph/kph)	90/145				
Compressed Air Required (psi/bar)	90-100/6.2-6.9				
Operating Temperature	150°F/ 66°C				
Control Voltage	120 VAC -or- 24 VDC				
Valves/Controls	60 Hz				

SYSTEM CURVES

Unlike other technologies that require upgrades for more demanding applications, each TG footprint comes standard with a unique high performance power pack. The system performance graphs below show the fan performance with clean filters. The curve indicates available external static pressure to the unit.

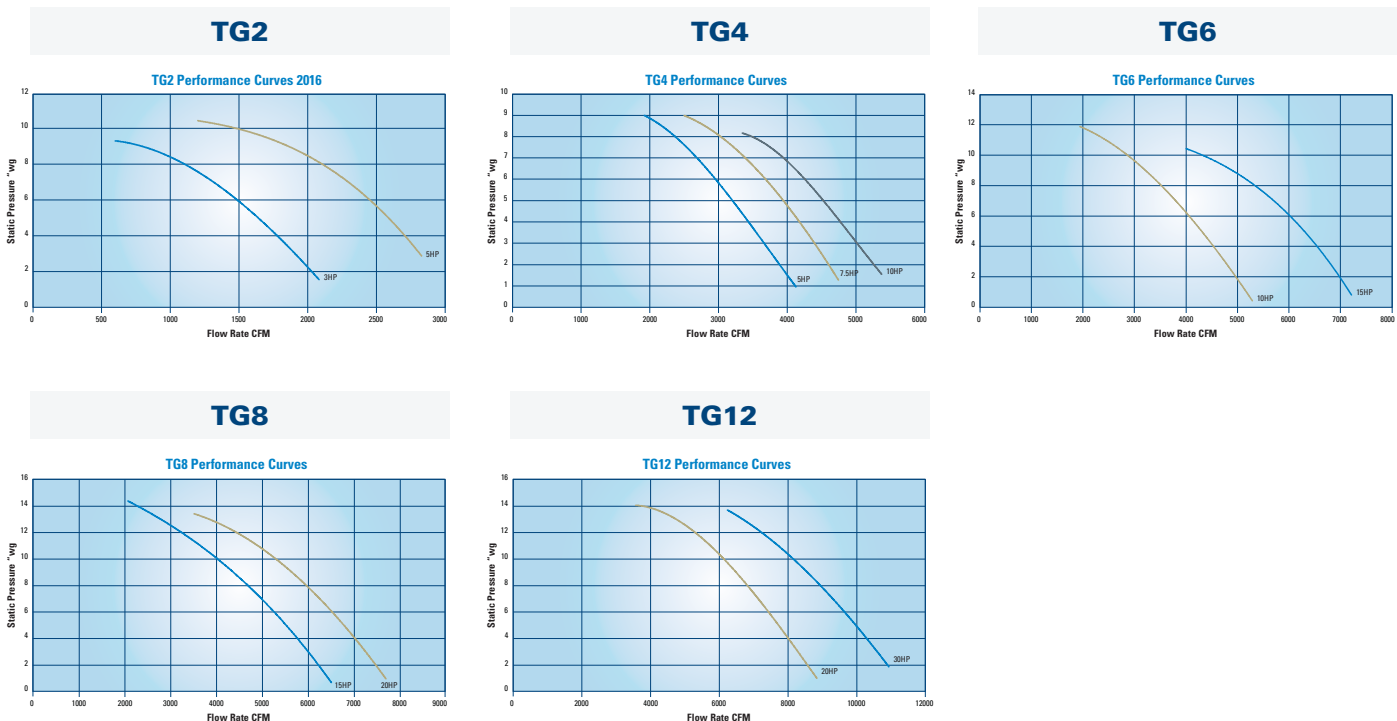

DIMENSIONS & SPECIFICATIONS

MODELS TG2 TO TG12

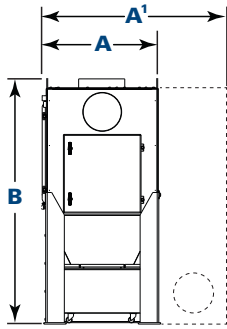

TG2
Front View

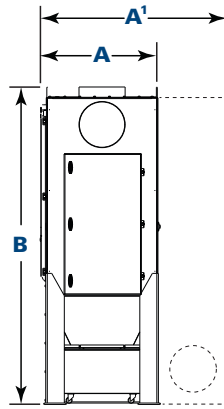

TG4
Front View

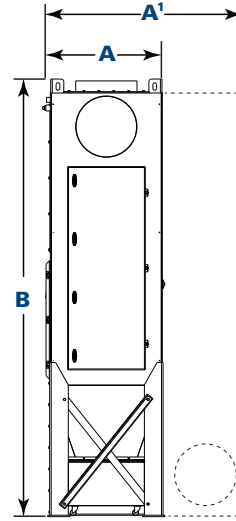

TG6
Front View

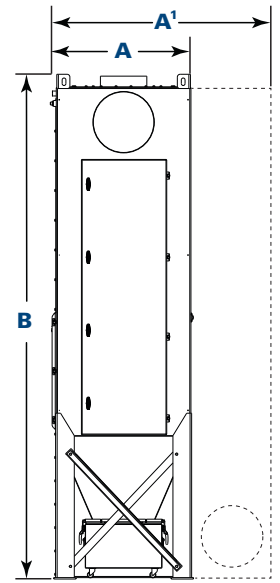

TG8
Front View

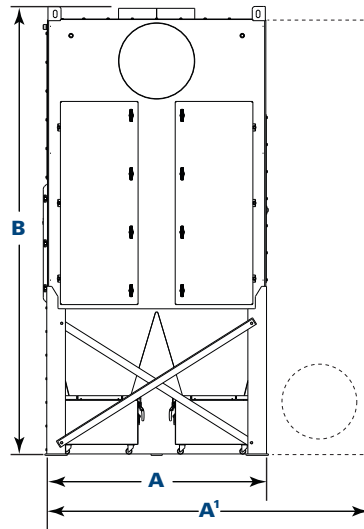

TG12
Front View

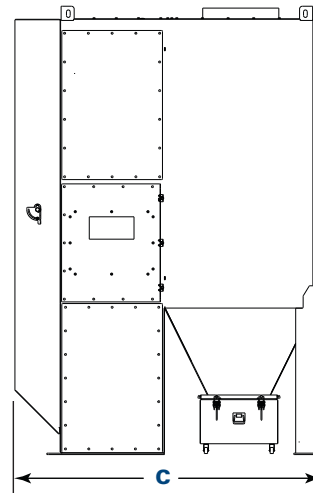

TG2, 4, 6, 8, 12
Side View

Model	Nominal Airflow Range* (cfm)	No. of Filter Packs	PowerCore Filter Area (ft ²)	No. of Valves	Shipping Weight			Dimensions (inches)			
					Std Housing (lbs)	R Housing (lbs)	Low-Inlet Box (lbs)	A	A'''	B	C
TG2	600 - 2750	2	294	2	1100	1150	1700	30.8	47.1	66.6	83.2
TG4	2000 - 4800	4	588	4	1600	1650	2025	31.0	47.1	86.1	82.1
TG6	2300 - 6600	6	882	6	2250	2350	2800	31.2	51.6	117.2	82.1
TG8	2500 - 7000	8	1176	8	2900	3400	3300	36.8	59.1	135.0	82.2
TG12	4000 - 10,500	12	1764	12	4120	4600	4700	59.7	85.6	120.3	83.2

* Based on clean filters.

** Width includes optional Low-Inlet Box

SMARTER PERFORMANCE ON HUNDREDS OF APPLICATIONS

While PowerCore filter packs are new to the metalworking market, they have a proven track record in other related filtration industries. Donaldson offers them in many shapes and sizes for high performance vehicles, construction, agricultural and medium/heavy duty transportation applications as well as gas turbine air intakes that protect multi-million dollar turbine engines for power plants across the globe. Donaldson Torit introduced the PowerCore CPC and CPV collectors for the baghouse markets in 2008.

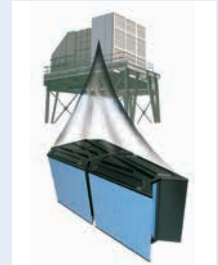

TG6 on Plasma Cutting



TG4 on Plasma Cutting



TG4 on Welding



TG4 on Laser Cutting

VISIT DONALDSON.COM/TORITPOWERCORE FOR LATEST CASE STUDIES.

STANDARD FEATURES & AVAILABLE OPTIONS

COLLECTOR DESIGN [†]	STD	OPT	FILTER PACKS	STD	OPT
Standard Housing	X		PowerCore FR (Flame-Retardant) with Ultra-Web (MERV* 13)	X	
Reinforced Housing		X	PowerCore AS (Anti-Static) with Ultra-Web (MERV* 13)		X
Robust All-Welded Construction	X		HOPPER DISCHARGE		
Strong 3/16 to 12 Gauge Mild Steel Structure per IBC2006	X		17-Gallon Dust Container	X	
Downward Airflow Advantage	X		ELECTRICAL CONTROLS		
Inlet (Top or High Front)	X		Integrated Torit Delta P w/Motor Starter	X	
Low-Inlet Drop-Out Box		X	Integrated Torit Delta P Plus w/Motors Starter		X
Easy Filter Access – No Tools Required	X		with 24VDC START/STOP, Low-Voltage Feedback Relay		X
One Access Door with T-Handle Compression Latches	X		External Remote-Mount Torit Delta P w/Motor Starter		X
Filter Cradles with Rotary Filter Locks	X		External Remote-Mount Torit Delta P Plus w/ Motor Starter		X
ZERO-Turn Power Pulse Cleaning System	X		with 24VDC START/STOP, Low-Voltage Feedback Relay		X
Premium Efficiency Motors PE	X		with Particulate Sensor		X
Integrated High-Performance TEFC Fan Packs	X		with Airflow Controller with VFD		X
Integrated High-Static TEFC Fan Packs		X	Integrated Electrical Enclosures NEMA 12	X	
Integrated High-Performance EXPR Fan Packs		X	Remote-Mount Electrical Enclosures NEMA 4	X	
Integrated High-Static EXPR Fan Packs		X	PAINT SYSTEM		
Sprinkler Couplings	X		Textured Multi-Coat Paint Finish with 2,000-Hour Salt Spray Performance	X	
Built-In Exhaust Silencer	X		Premium Duty Finish		X
Built-In Damper Valve	X		Custom Colors, Materials and Finishes		X
Top Exhaust Outlet	X		WARRANTY		
Integrated Rear HEPA Filters		X	10-Year Warranty	X	
Rear Weatherhood		X	* The Minimum Efficiency Reporting Value (MERV) of this filter cartridge has been determined through independent laboratory testing using ASHRAE 52.2 test standards. The MERV rating was determined at a face velocity of 118 feet (36.0 meters) per minute and loading up to four inches (101.6 mm) water gauge. Actual efficiency of any filter cartridge will vary according to the specific application parameters. Dust concentration, airflow, particle characteristics, and pulse cleaning methods all affect filtration efficiency.		
Top Mount HEPA Filters		X	† Donaldson Torit equipment is designed to IBC guidelines for specific wind speed exposure and seismic spectral acceleration at grade level. Contact your Donaldson Torit representative for detailed information available on the equipment's Spec Control drawings. Equipment may be customized to meet unique, customer-specified site requirements.		
COST CONTROL					
Completely Packaged—One-Stop Shopping	X				
Fully Assembled—Minimal Installation Efforts	X				
Pre-Wired—Minimal On-Site Wiring	X				
Smaller Collectors—Save Freight Costs & Space	X				
Fewer Filter Changes—Less Downtime, Maintenance	X				
Quiet Energy Efficient Power Packs	X				
Energy Saver Package		X			
SAFETY FEATURES					
Top-Mount Explosion Vents per NFPA 68-2007		X			
Side-Mount Explosion Vents per NFPA 68-2007		X			
Explosion Suppression		X			
Sprinkler Pack		X			
Electrical Grounding and Bonding		X			
Inline Spark Cooler		X			
Fire Suppression		X			

Industry-Leading Technology

- Advanced filtration technology for optimal performance
- Reduced energy consumption and cost of ownership
- Advanced design and testing capabilities

The Most Filters and Parts

- For every brand and style of collector
- Wide range of filtration media for any application
- 90,000 filters and parts in stock and ready to ship

Unparalleled Support

- Live technical specialists
- Comprehensive pre- and post-sale support
- 40 manufacturing plants and 14 distribution centers worldwide

Significantly improve the performance of your collector with genuine Donaldson Torit replacement filters and parts. **Call Donaldson Torit at 800-365-1331.**

Important Notice

Many factors beyond the control of Donaldson can affect the use and performance of Donaldson products in a particular application, including the conditions under which the product is used. Since these factors are uniquely within the user's knowledge and control, it is essential the user evaluate the products to determine whether the product is fit for the particular purpose and suitable for the user's application. All products, product specifications, availability and data are subject to change without notice, and may vary by region or country.



Donaldson.

Donaldson Company, Inc.
Minneapolis, MN
donaldson.com • shop.donaldson.com

North America
Email: donaldson@donaldson.com
Phone: (USA): 800-365-1331 • (MX): 800-343-3639

Australasia
Email: marketing.australia@donaldson.com
Phone: +61 2 4350 2000
Toll Free: (AU) 1800 345 837 • (NZ) 0800 743 387

F118040 ENG (06/18) PowerCore Dust Collectors - TG Series ©2011-2018 Donaldson Company, Inc.
Donaldson, Torit, PowerCore, Ultra-Web and the color blue are marks of Donaldson Company, Inc. All other marks belong to their respective owners.

China IAF
Email: info.cn@donaldson.com
Phone: (86) 400-820-1038

Donaldson Europe B.V.B.A.
Email: IAF-europe@donaldson.com
Phone: + 32 (0) 16 38 38 11

India
Email: marketing.India@donaldson.com
Phone: +91 124 4807400
Toll Free: 18001035018

Latinoamerica
Email: IndustrialAir@donaldson.com
Phone: +52 449 300 2442

South Africa
Email: SAMarketing@donaldson.com
Phone: +27 11 997 6000

Southeast Asia IAF
Email: IAF.SEA@donaldson.com
Phone: (65) 63117373